



TAKISAWA[®]
TAIWAN

/// **Taiwan TAKISAWA Technology Co., Ltd.**

Pinchen /
No. 505, Sec 3, Yenping Rd., Pingchen Dist.,
Taoyuan City 324, Taiwan
TEL: +886-3-4643166 FAX: +886-3-4642614

Yangmei /
No. 89, Sec. 1, Meishi Rd., Yangmei Dist.,
Taoyuan City 326, Taiwan
TEL.: +886-3-4813119 FAX: +886-3-4813185
E-mail: callcenter@takisawa.com.tw

/// **Shanghai TAKISAWA Mechatronics Ltd.**

Shanghai /
No. 1568, Yuanguo Road, Anting Town,
Jiading District, Shanghai
TEL: +86-21-59562955 FAX: +86-21-59562956

/// www.takisawa.com.tw



LA-350 Series

LA-350L8 · L16 · L22 / LA-350ML8 · ML16 · ML22

LA-450L8 · L16 · L22 / LA-450ML8 · ML16 · ML22

LA-450 Series

TAKISAWA[®]
TAIWAN

LA-350 | LA-450 Series

The LA-350 450 series is a new generation high precision heavy duty turning center developed for highly precise machining, through its extremely strong rigid structure and high-precision machining of large diameter workpieces.

Largest spindle bore bar stock diameter increased to Ø150. The 2-step gear box provides extra high torque during low speed machining for outstanding heavy cutting performance.

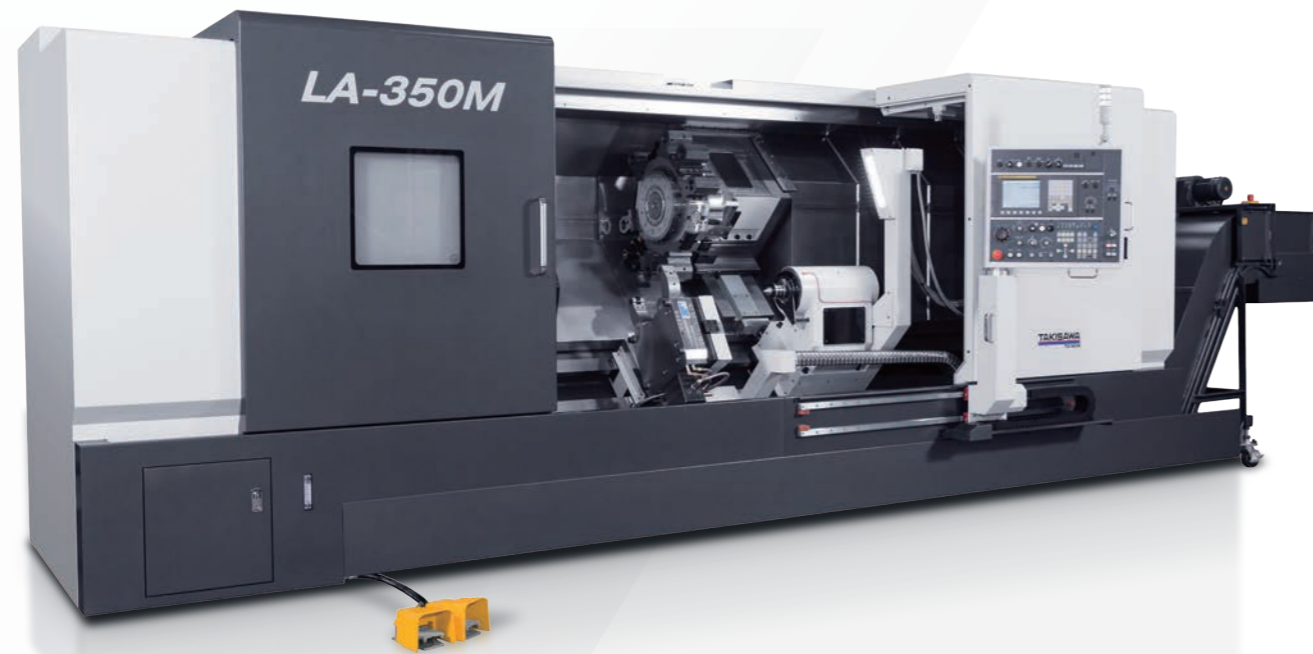

High-rigidity machine body structural design and thermal displacement by FEM analysis. 45 degree slant bed design provides optima machining performance. The box guide slidways are hardened by induction heat treatment which supports the best hardness of rigidity structure. Large-diameter ball screws for dynamic rigidity.

Specification Options

●:Standard ○:Optional ---:Nope

	LA-350 [L8][L16][L22]	LA-350M [L8][L16][L22]	LA-450 [L8][L16][L22]	LA-450M [L8][L16][L22]
GearBox Spindle	●	●	●	●
T10 Turning Turret	●	---	●	---
T12 Turning Turret	○	---	○	---
T12 Milling Turret	---	●	---	●
Pin Carry Tailstock	●	●	●	●

Workpiece Size

	LA-350 [L8][L16][L22]	LA-350M [L8][L16][L22]	LA-450 [L8][L16][L22]	LA-450M [L8][L16][L22]	
Max. Turning Diameter	21.65	18.90	21.65	18.90	inch
Max. Turning Length	[32.68][64.17][89.37]	[27.99][59.49][84.69]	[30.75][62.24][87.44]	[26.06][57.56][82.76]	inch
Max. Bar Work Capacity Diameter	4.53	4.53	5.91	5.91	inch

※ Specifications are subject to change without notice.

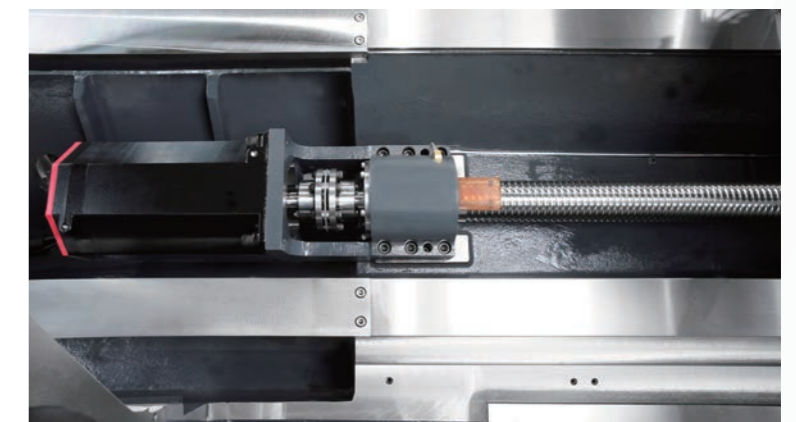
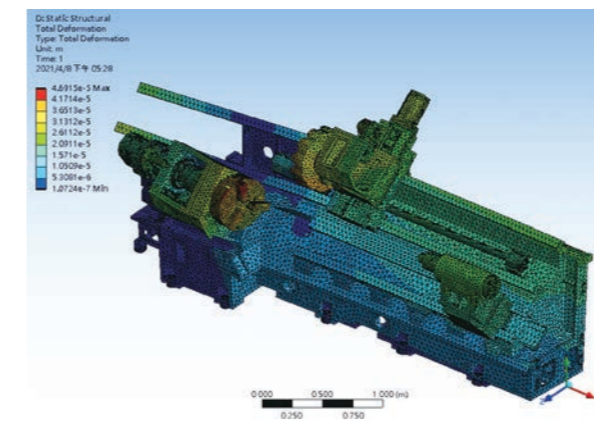

Travel & Rapid Traverse

	LA-350 [L8][L16][L22]	LA-350M [L8][L16][L22]	LA-450 [L8][L16][L22]	LA-450M [L8][L16][L22]	
X-Axis Travel	11.42	10.83	11.42	10.83	inch
X-Axis Rapid Traverse	629.92	629.92	629.92	629.92	ipm
Z-Axis Travel	[33.46][64.96][90.16]	[31.89][63.39][88.58]	[33.46][64.96][90.16]	[31.89][63.39][88.58]	inch
Z-Axis Rapid Traverse	[787.40][787.40][629.92]	[787.40][787.40][629.92]	[787.40][787.40][629.92]	[787.40][787.40][629.92]	ipm

※ Specifications are subject to change without notice.

Spindle

Taiwan Takisawa home-made spindle equipped with high quality bearings sourced from Europe and Japan. The rigid spindle structure supports resistance to deformation, powerful machining capability and solid durability.

For all LA models equipped with gearbox, the gears are all with 0-grade fine ground precision. The gearbox allows cutting at high torque in low speed range, combined with a highly accurate finish surface.

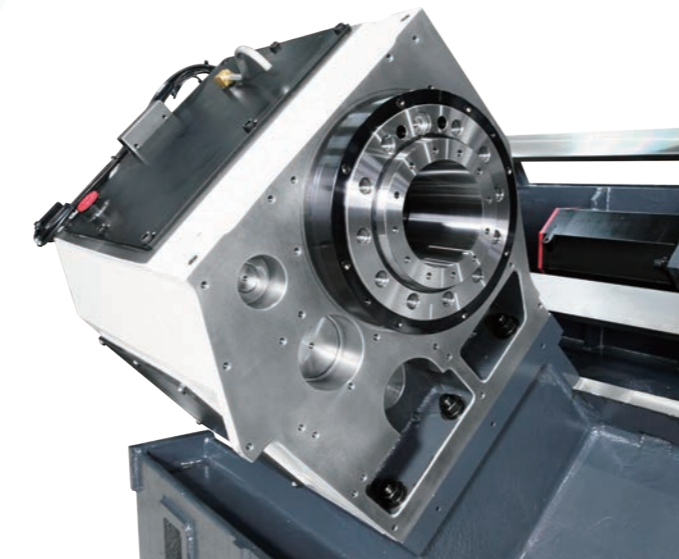
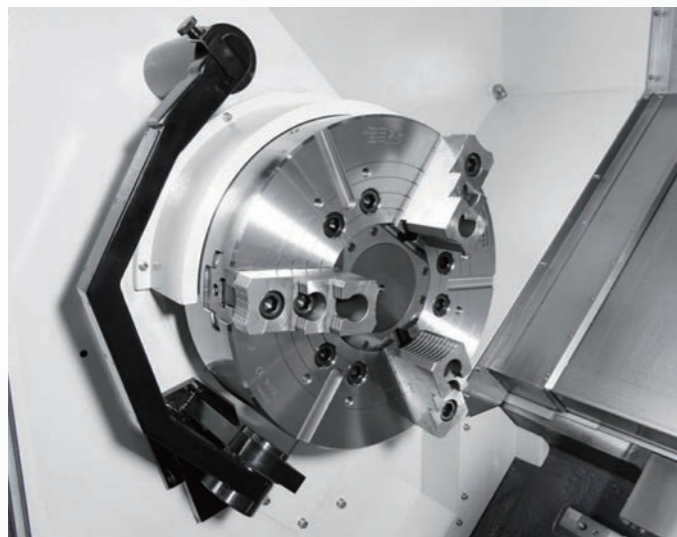
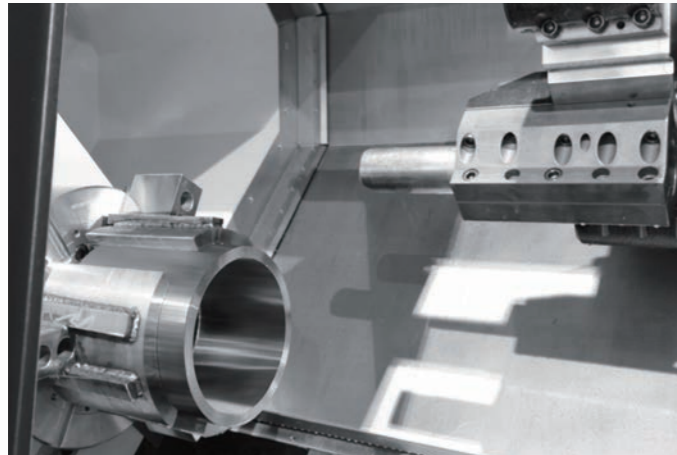

Max. spindle speed

LA-350 / 350M	LA-450 / 450M
12" 2500 min-1	18" 1800 min-1
15" 2000 min-1	20" 1500 min-1

※ Specifications are subject to change without notice.

Through-spindle hole diameter

LA-350 / 350M	LA-450 / 450M
126 mm	162 mm

※ Specifications are subject to change without notice.

Spindle Specification

	LA-350 [L8][L16][L22]	LA-350M [L8][L16][L22]	LA-450 [L8][L16][L22]	LA-450M [L8][L16][L22]	
	GearBox		GearBox		
Spindle Nose	A2-11		A2-11		
Spindle Speed	2500 [2000]		1800 [1500]		rpm
Through Hole Diameter	4.96		6.38		inch
Bearing Inside Diameter	6.69		8.66		inch
Motor Output	29.5/24.8 (34.9/29.5)		34.9/29.5 (49.6/40.2)		HP
Max. Torque	948 (1120)		1002 (1860)		ft·lbf

※ Specifications are subject to change without notice.

Spindle Output Diagram

LA-350 Series

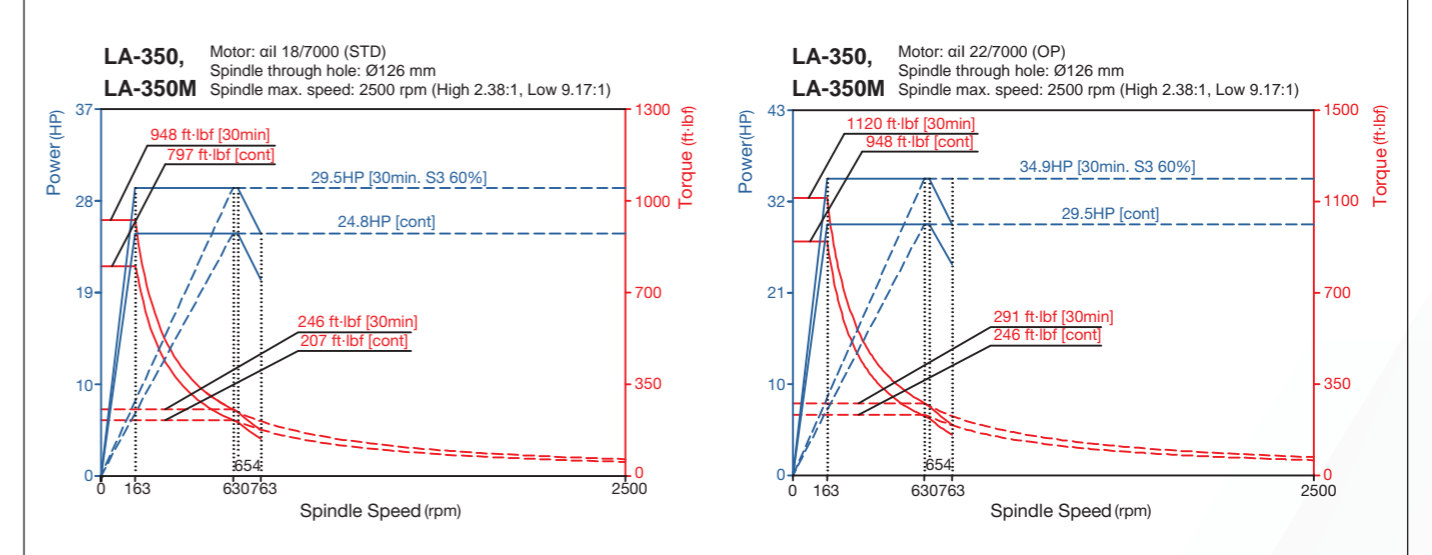

LA-450 Series

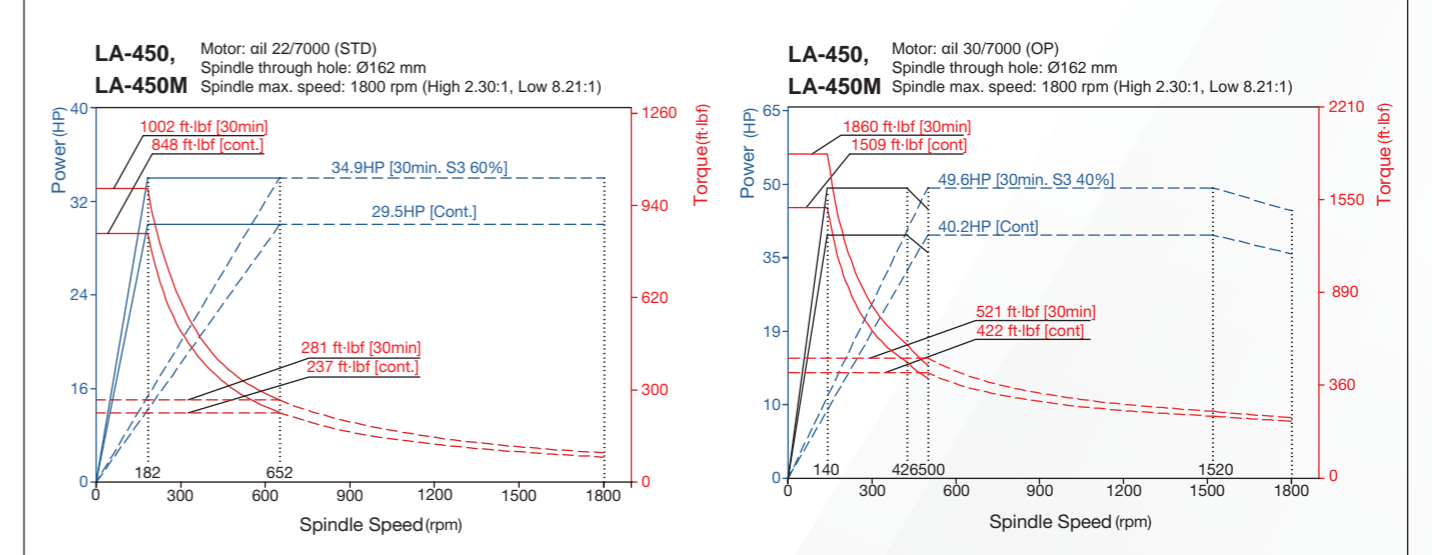

Turret

The high performance turrets are also home-made by Taiwan Takisawa, the two-piece high precision coupling provides not only high clamping force, but also rapid and accurate indexing. It's easy to calibrate positioning in both the CW and CCW direction.

We can provide a customised needs assessment for special needs regarding numbers of tools, tool holders, milling cutters etc.

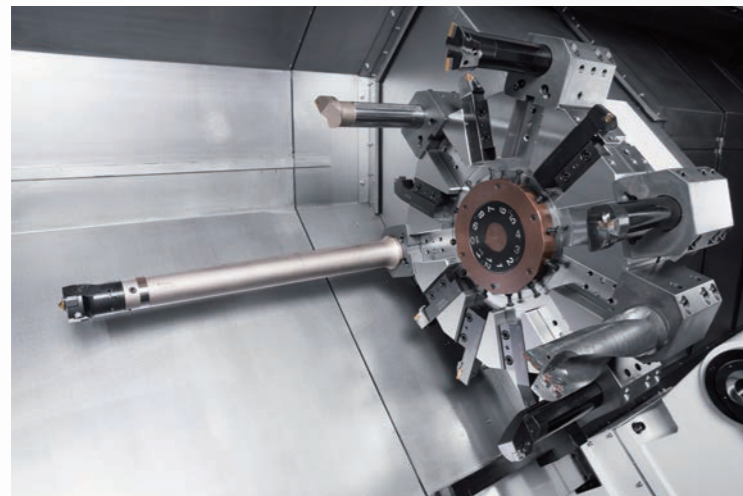
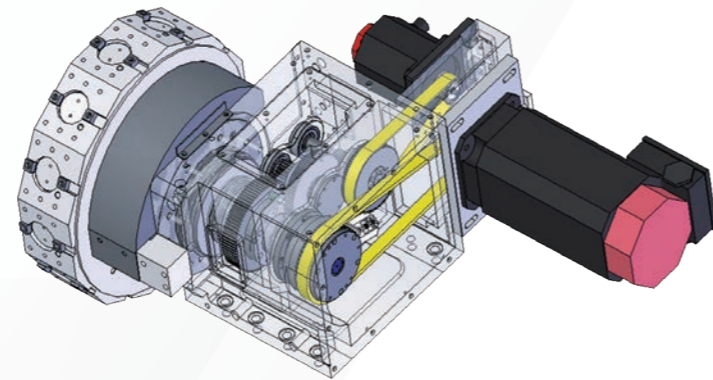

Turning Turret

	●	◎	
Number of Tools	10	12	
OD Tool Shank Dimension	1.25	1.25	inch
ID Tool Shank Diameter	2 [2.5]	2 [2.5]	inch

●:Standard ◎:Optional ---:None

Milling Turret

	●	
Number of Tools	12	
OD Tool Shank Dimension	1.25	inch
ID Tool Shank Diameter	2	inch
Milling Shank Diameter	1.02	inch
Milling Spindle Speed	3500	rpm
Motor Output	5 (10)	HP
Max. Torque	65.4	ft-lbf

●:Standard ◎:Optional ---:None

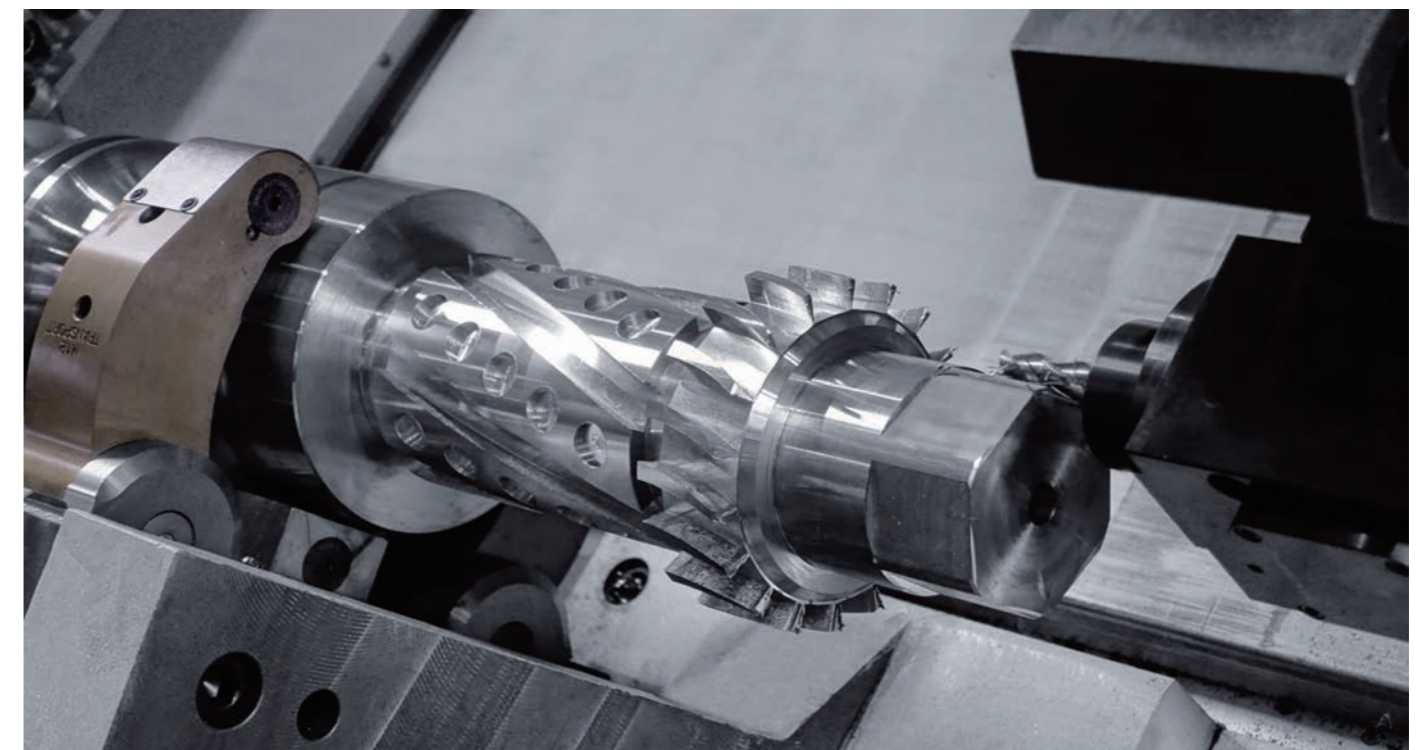

Spindle Output Diagram

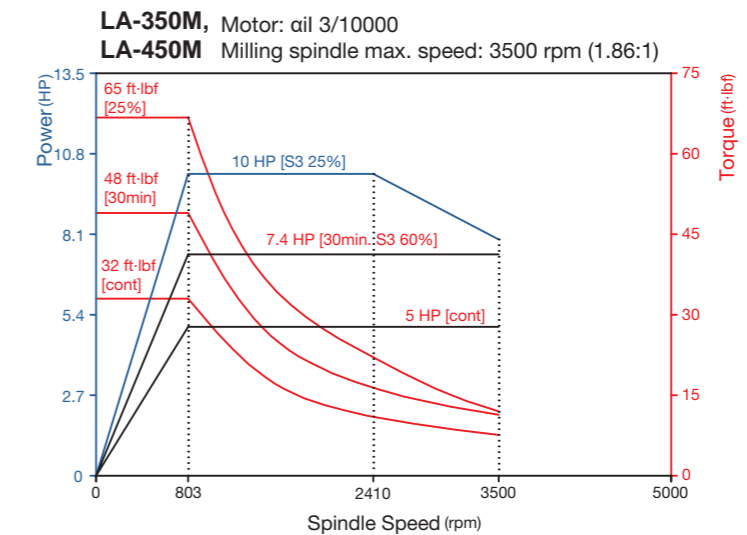

Special Tool Holders

- 01** Gear Hobbing
- 02** Broaching
- 03** Power Skiving
- 04** Adjustable Angle Milling



Tailstock

Taiwan Takisawa home-made tailstock with high thrust and strong clamping force, ensures maximum stability especially when working with long workpieces. The movement of tailstock body is carried by turret with easy positioning feature, the tailstock quill is available in fixed and rotary versions and the tailstock is pushed by hydraulic.

Special needs such as thrust size or quill form etc. can be assessed if customization is required.

/ Tailstock



/ Sub spindle tailstock (OP)

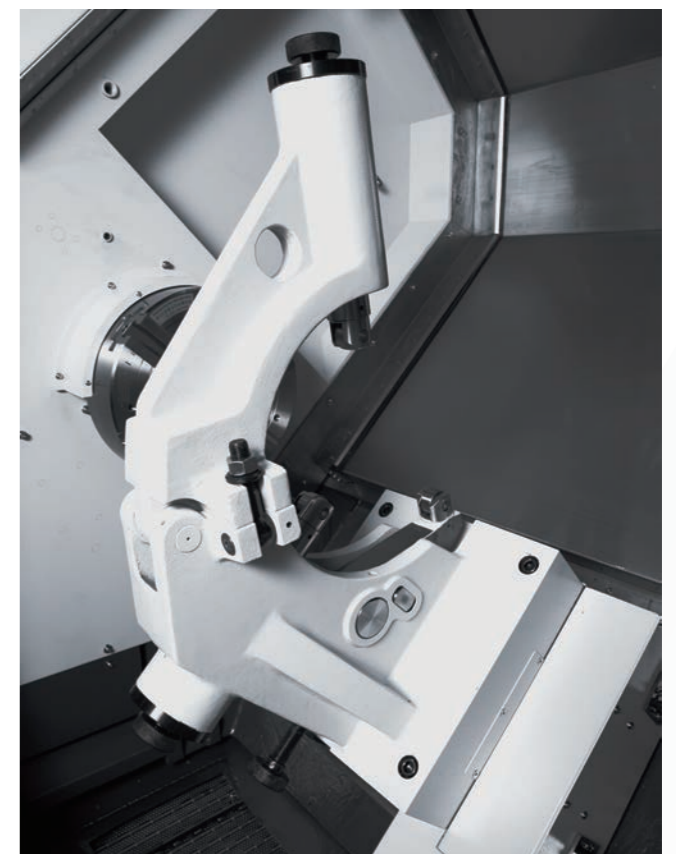
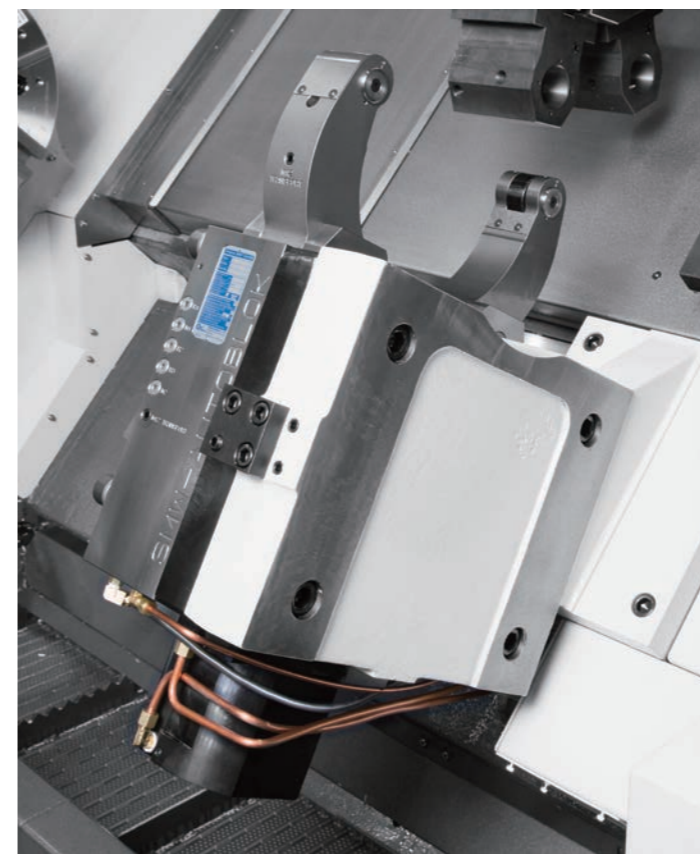
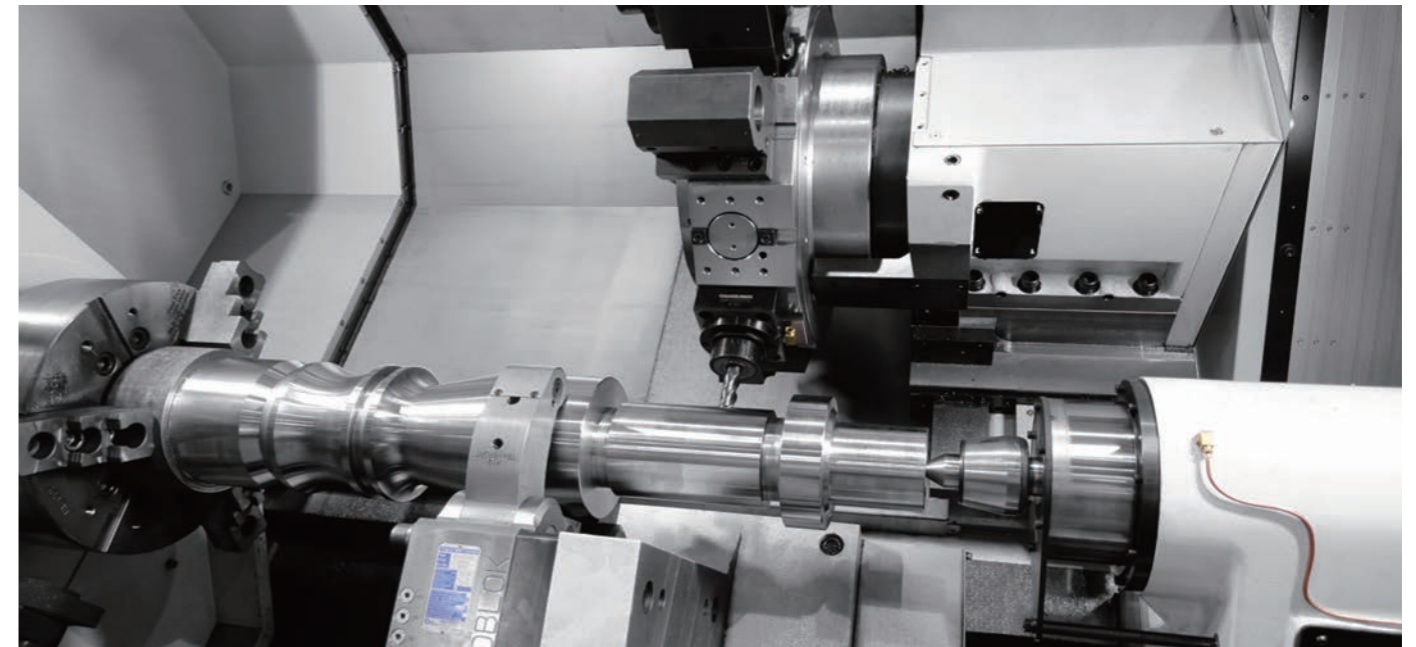
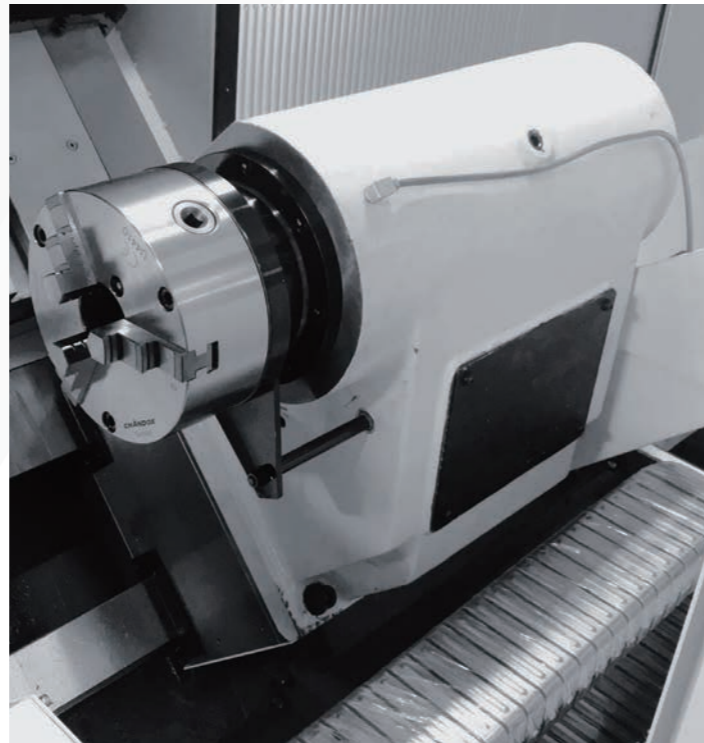

Tailstock

Tailstock Type	Live center	Built-In center	Built-In center	
Tapered Bore Type	MT.5	MT.5	MT.5	
Tailstock Spindle Diameter	5.91	5.91	5.91	inch
Tailstock Spindle Travel	5.91	5.91	11.81	inch
Tailstock Thrust	2866	2866	2866	ibf

※ Specifications are subject to change without notice.

Hydraulic Steady Rest

SMW SLU-Z-3	Ø0.47"~Ø5.98"	inch
SMW SLU-Z-3.1	Ø0.77"~Ø6.50"	inch
SMW SLU-Z-3.2	Ø1.97"~Ø7.87"	inch
SMW SLU-Z-4	Ø1.18"~Ø9.65"	mm
SMW SLUB-Z-4	Ø1.38"~Ø9.65"	inch

Manual Steady Rest

Manual rest	Ø1.97"~Ø13.78"	inch
-------------	----------------	------

※ Specifications are subject to change without notice.

Interference | Travel range

LA-350/450

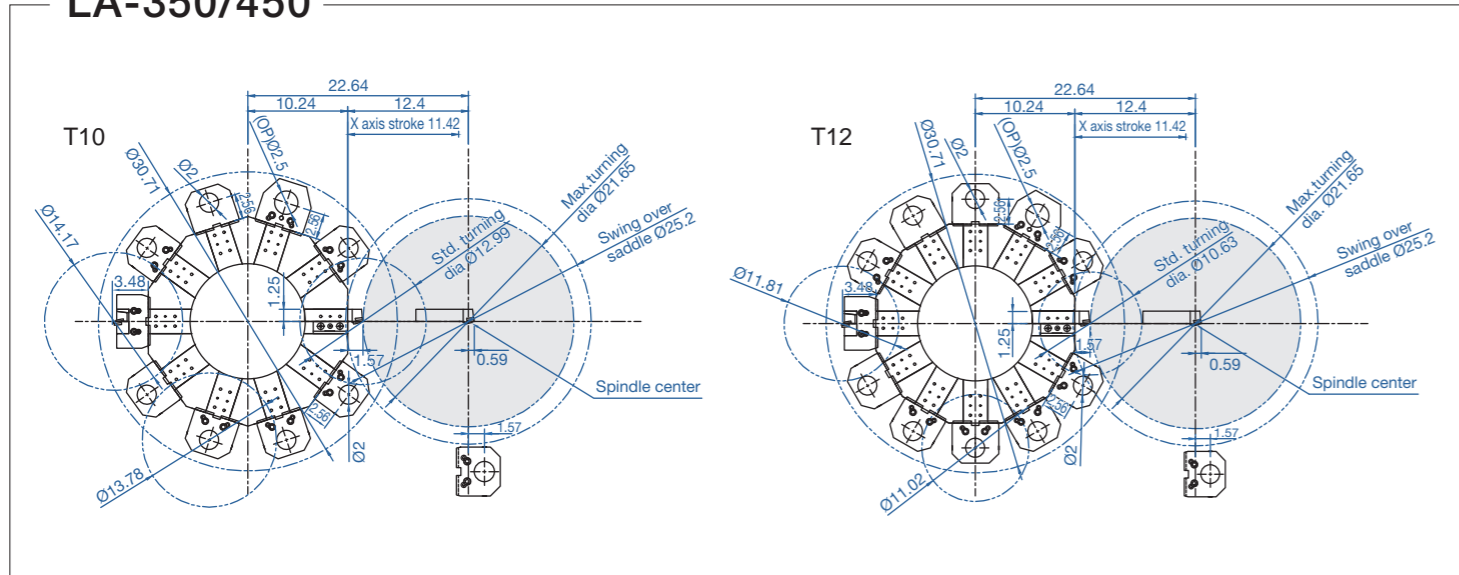

LA-350M/450M

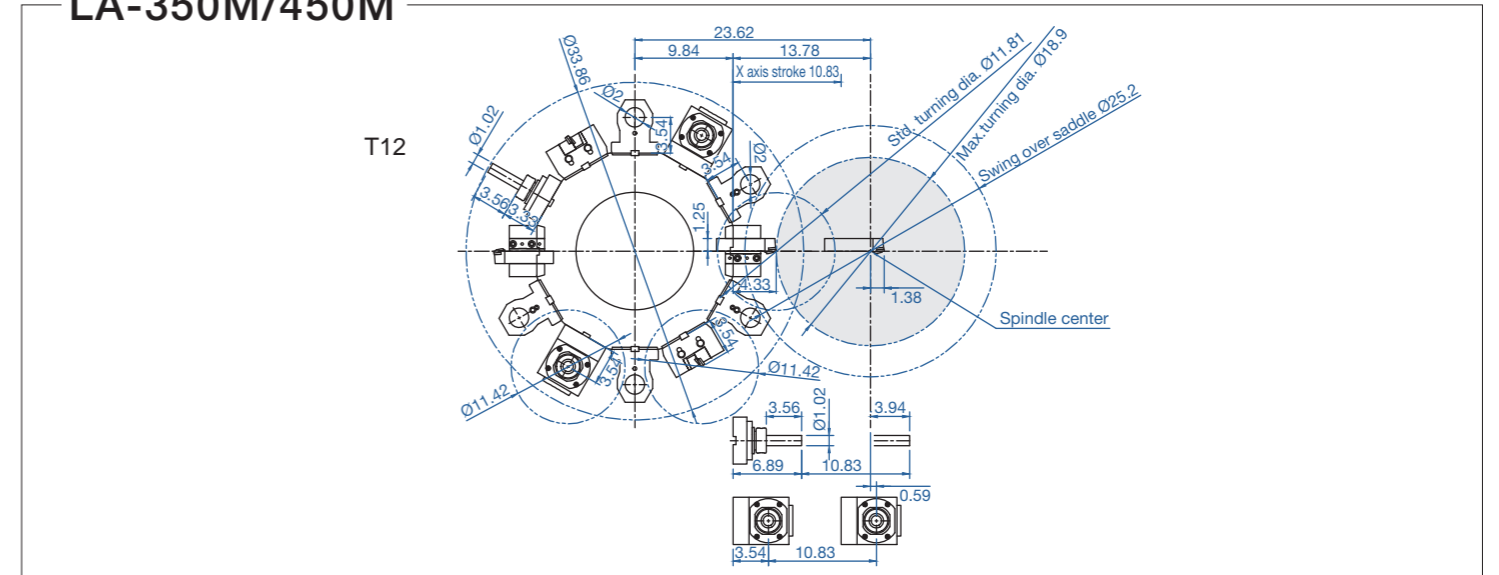

LA-350 T10/T12

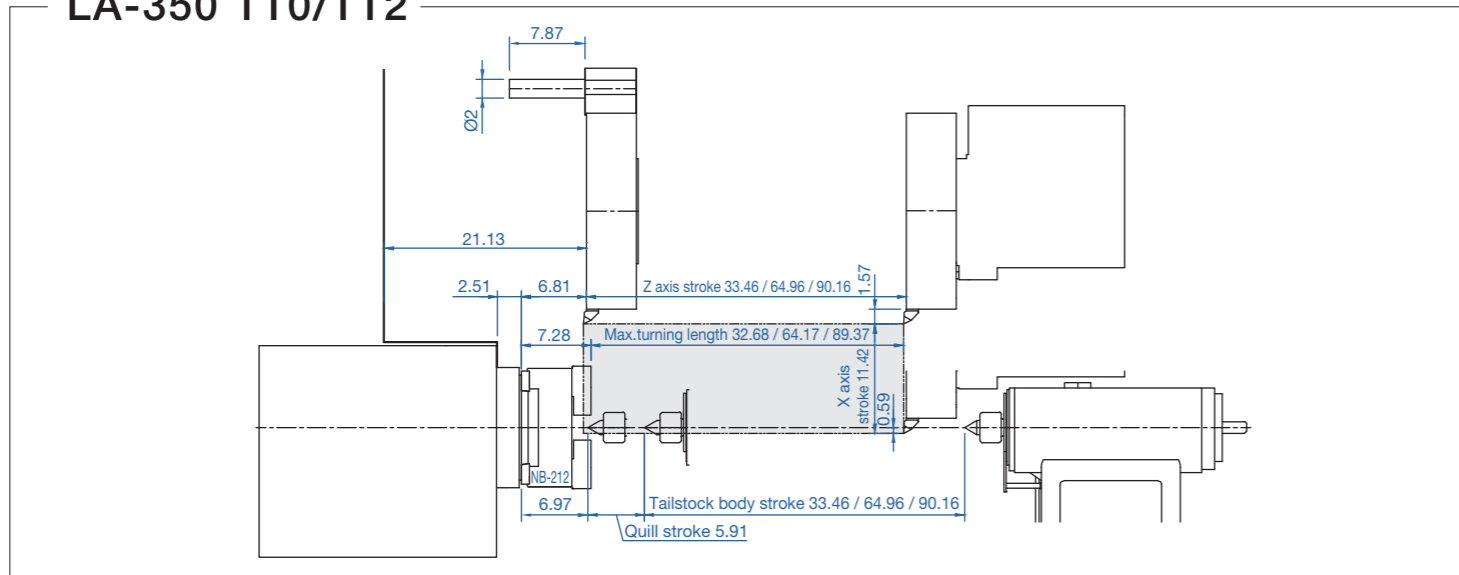

LA-350M T12

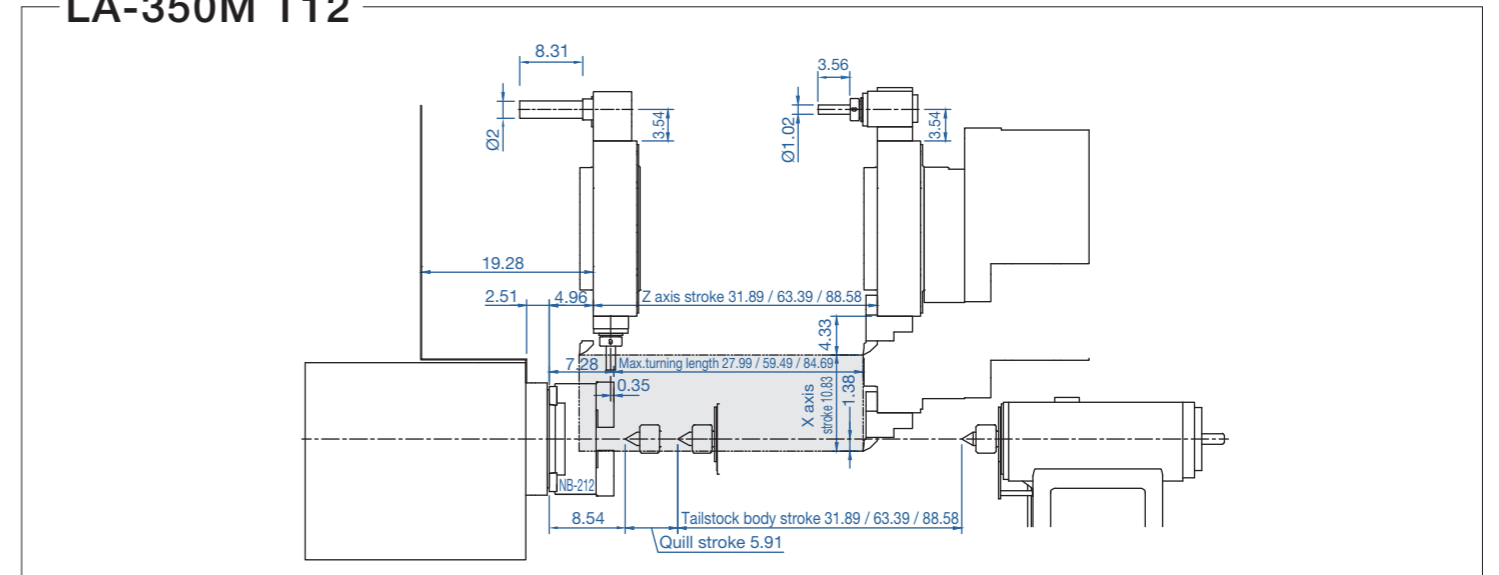

LA-450 T10/T12

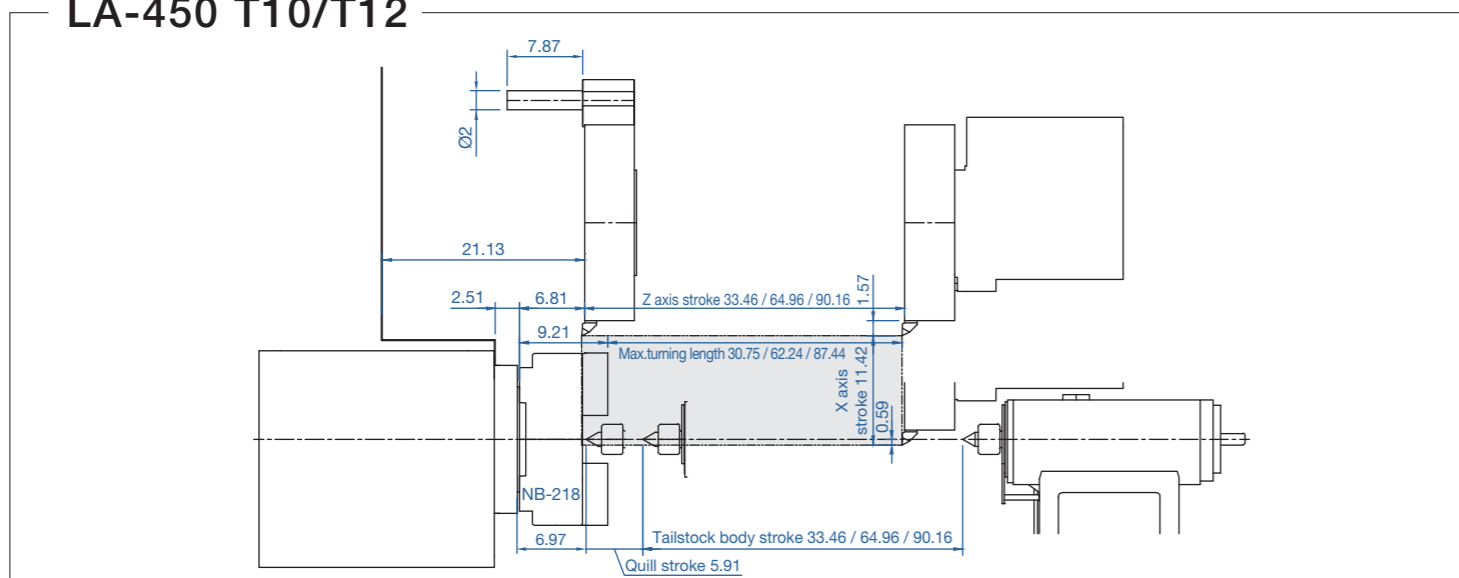

LA-450M T12

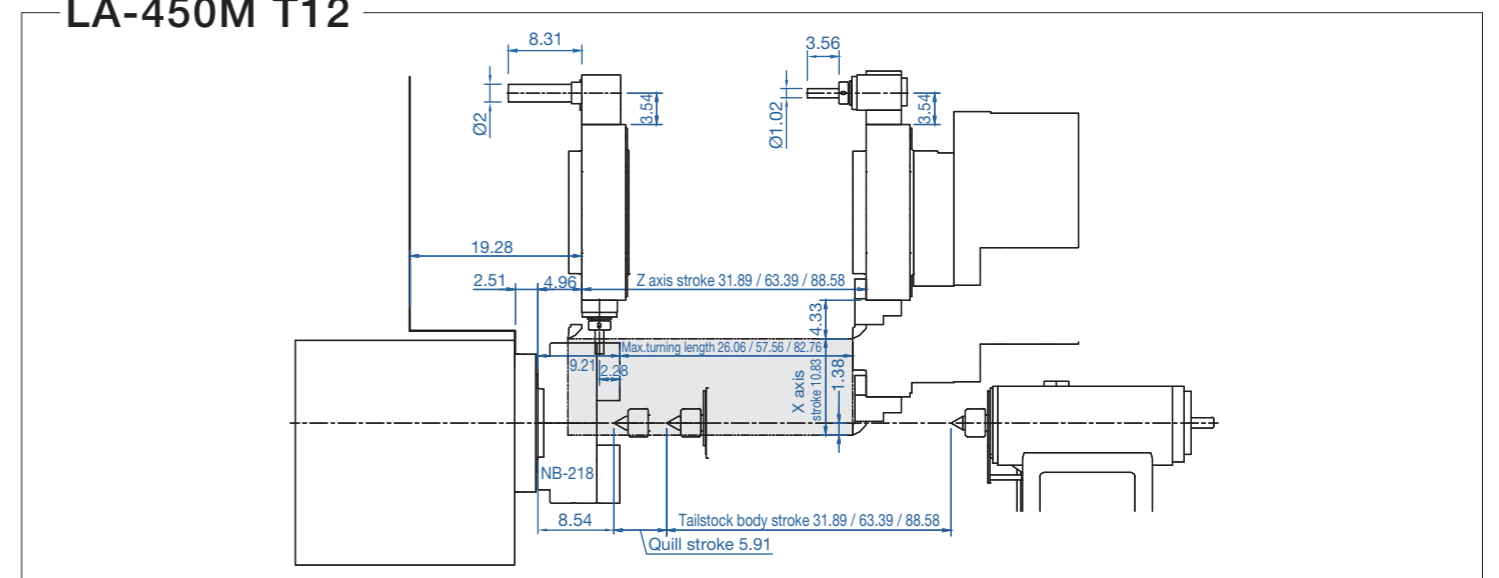

Tooling System

LA-350/450 T10/T12 Ø2"

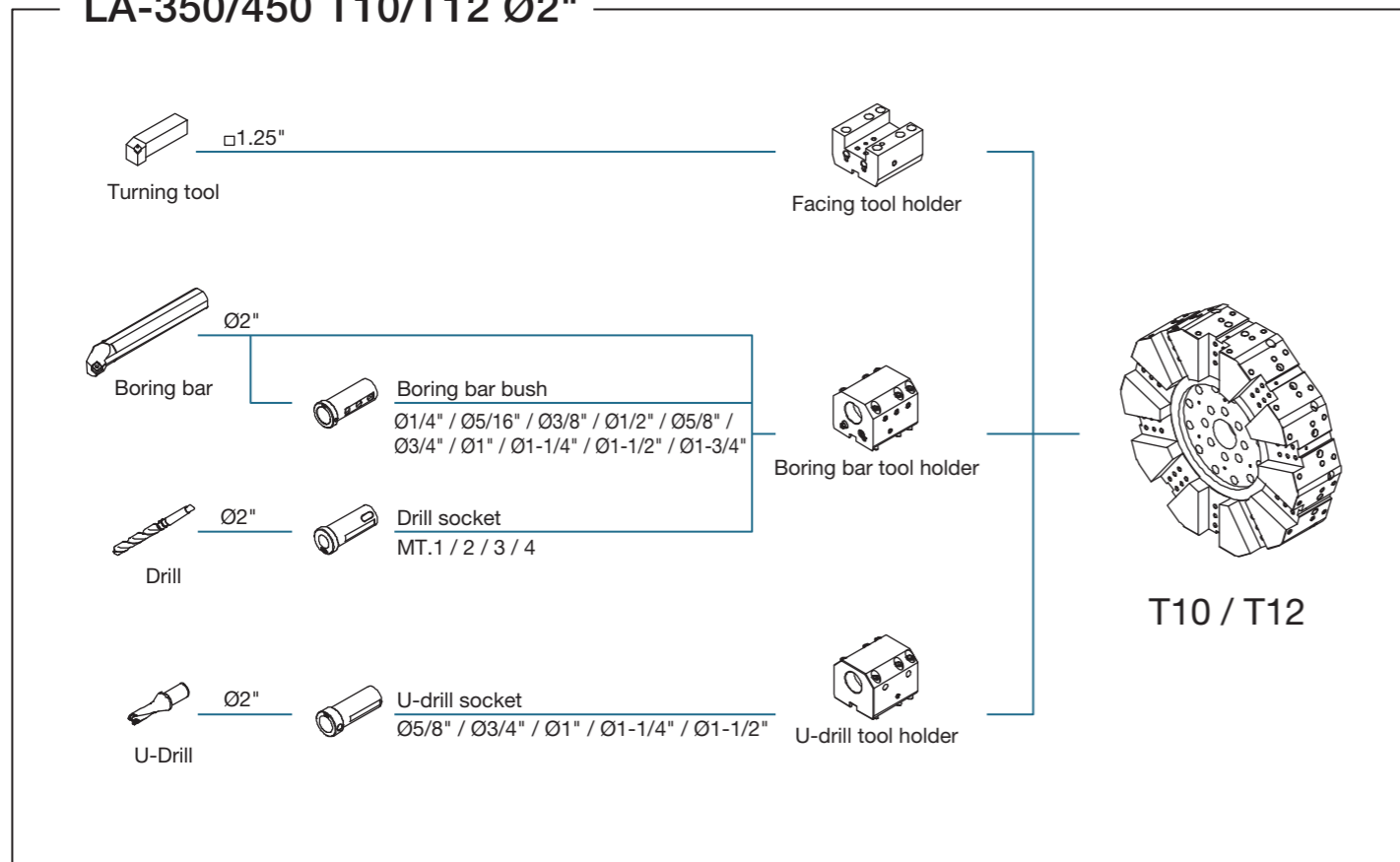

LA-350/450 T10/T12 Ø2.5"

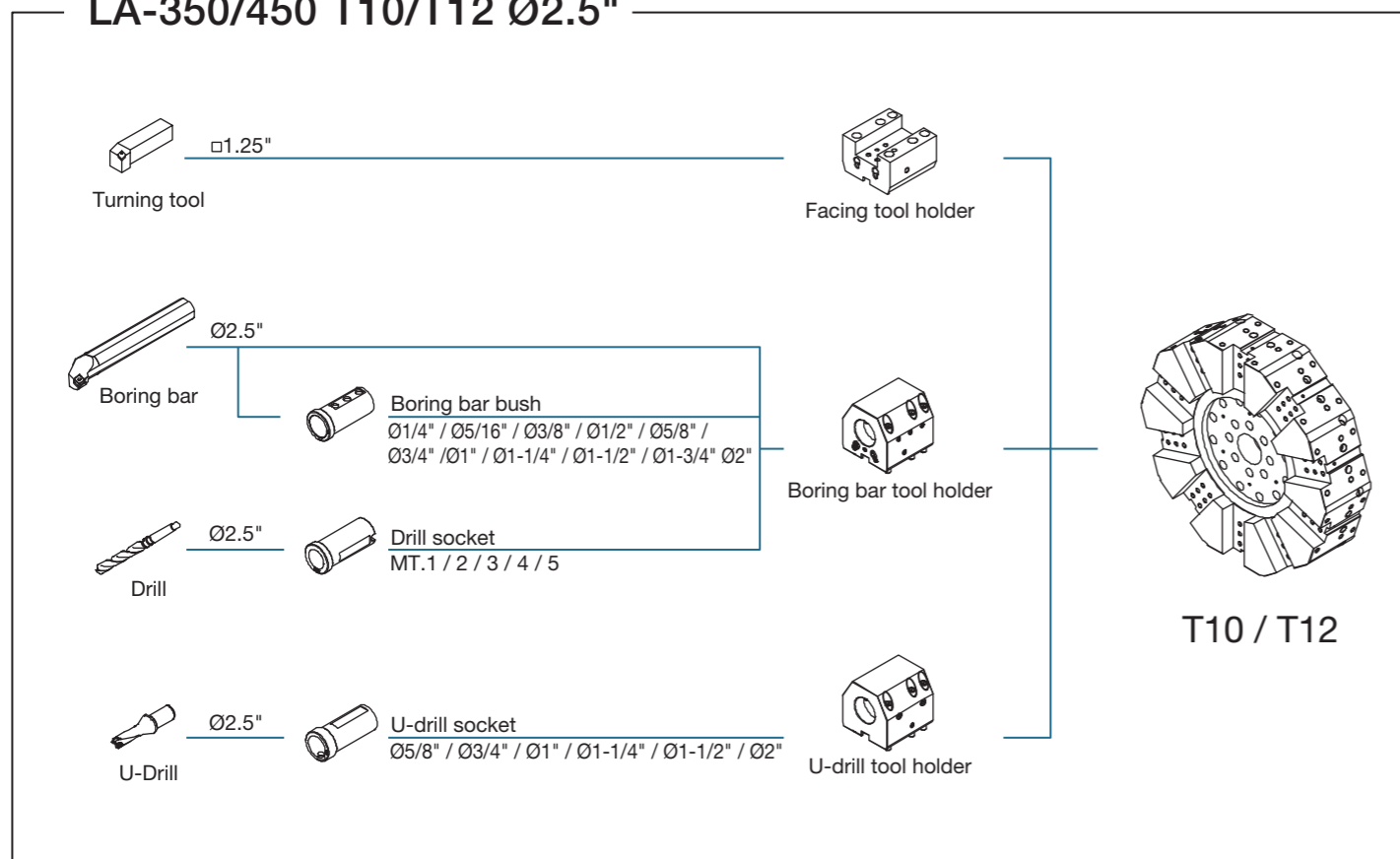

LA-350M/450M T12 Ø2"

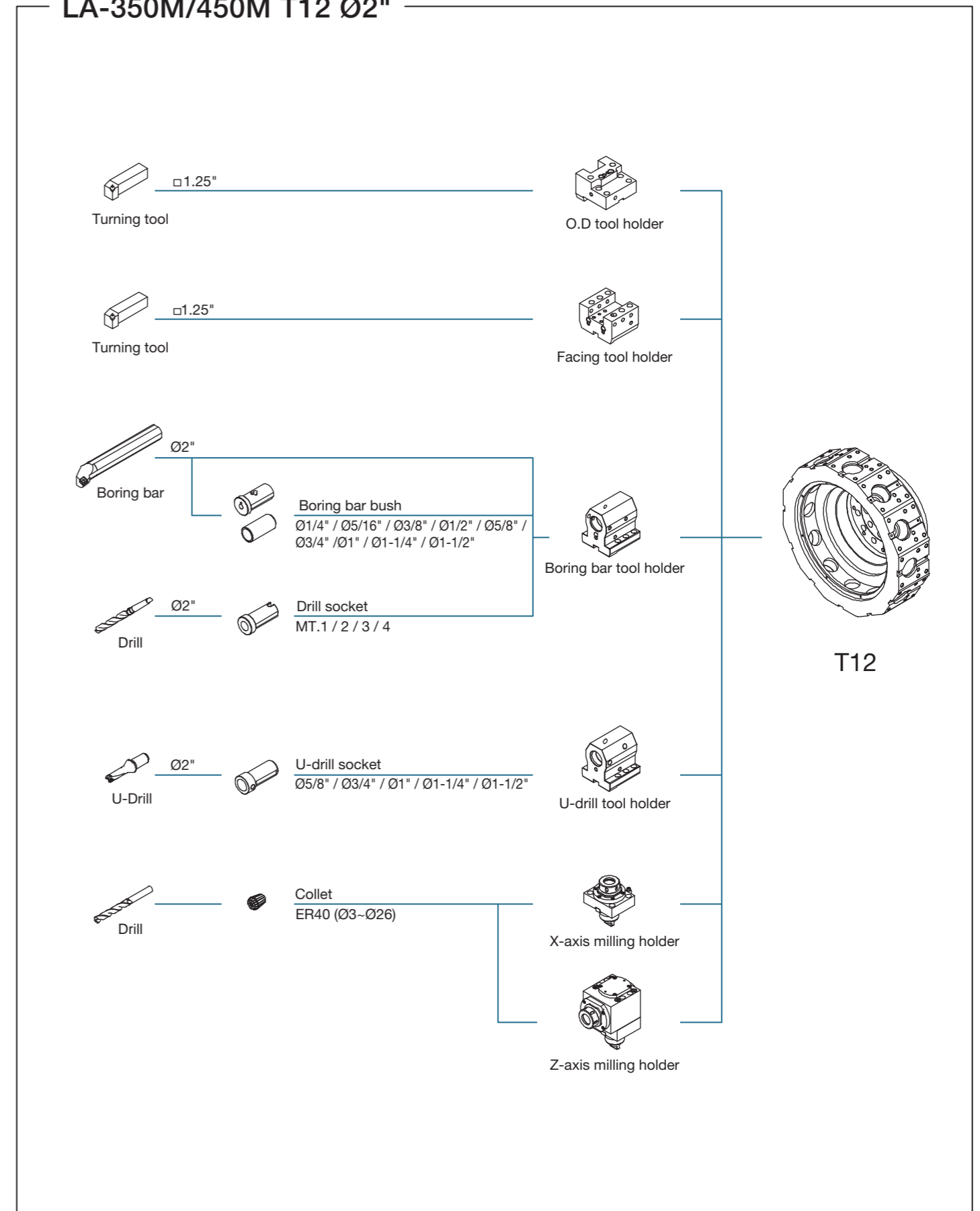

Machine Dimensions

LA-350/450, LA-350M/450M [L8]

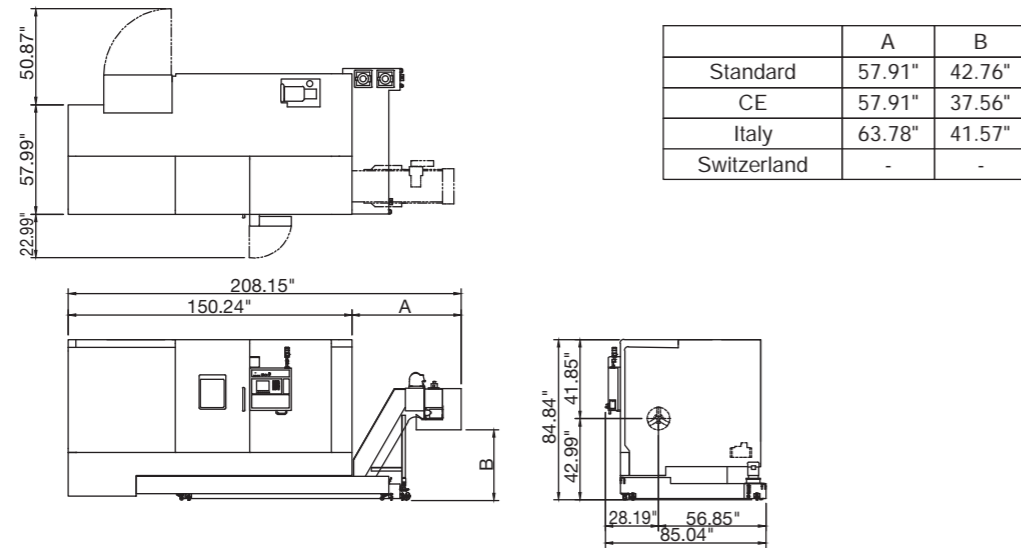

LA-350/450, LA-350M/450M [L16]

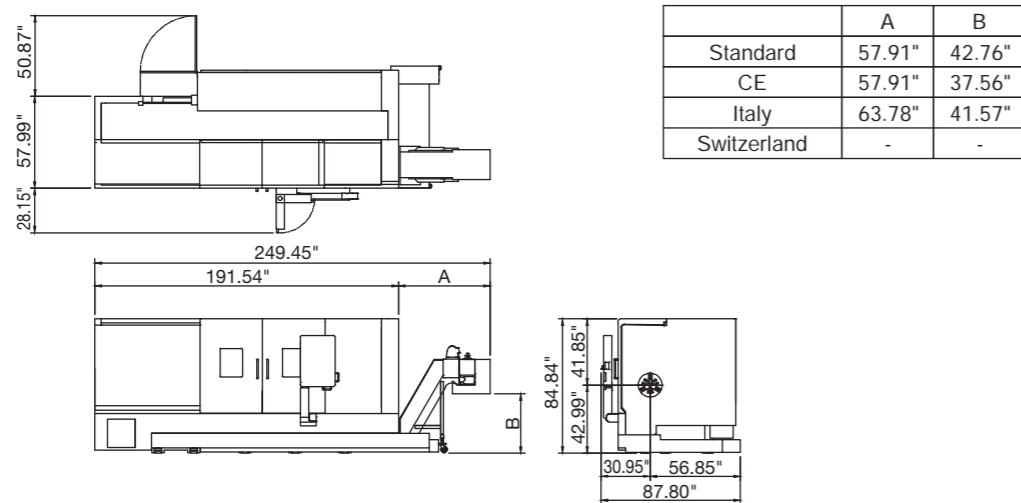

LA-350/450, LA-350M/450M [L22]

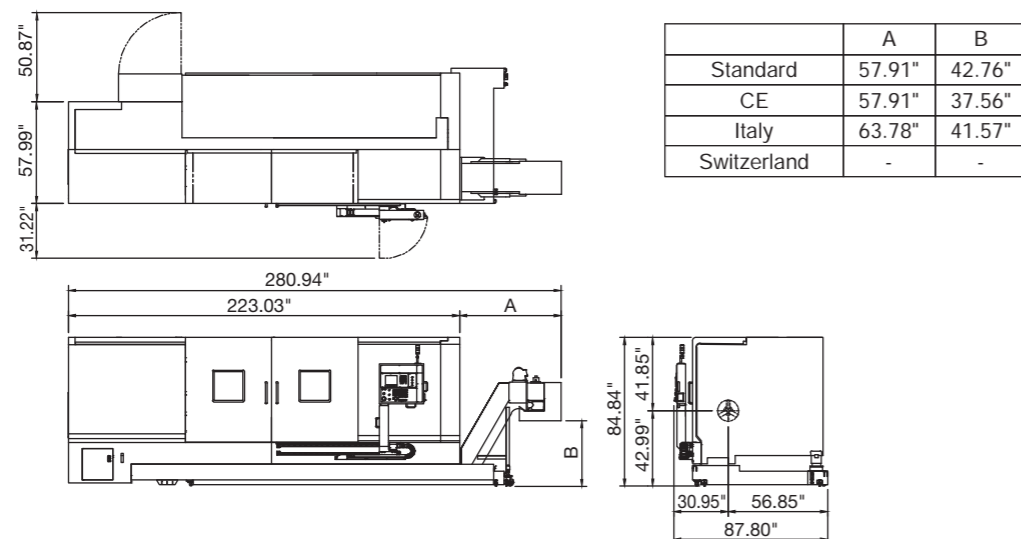

Specifications

Remark1:() Option

Model		LA-350	LA-350M	LA-450	LA-450M	
Item	Unit	L8/L16/22	L8/L16/22	L8/L16/22	L8/L16/22	
Capacity	Max. swing	inch	30.71	30.71	30.71	
	Swing over saddle	inch	25.20	25.20	25.20	
	Standard turning diameter	inch	12.99 [T10]/10.63 [T12]	11.81	12.99 [T10]/10.63 [T12]	11.81
	Max. turning diameter	inch	21.65	18.90	21.65	18.90
	Max. turning length	inch	32.68/64.17/89.37	27.99/59.49/84.69	30.75/62.24/87.44	26.06/57.56/82.76
Travel	Max. bar work capacity	inch	4.53	4.53	5.91	5.91
	X axis travel	inch	11.42	10.83	11.42	10.83
	Z axis travel	inch	33.46/64.96/90.16	31.89/63.39/88.58	33.46/64.96/90.16	31.89/63.39/88.58
Spindle	Y axis travel	inch	---	---	---	---
	Spindle speed	rpm	2500 (2000)	2500 (2000)	1800 (1500)	1800 (1500)
Spindle	Chuck size		12" (15")	12" (15")	18" (20")	18" (20")
	Spindle nose		A2-11	A2-11	A2-11	A2-11
	Through hole diameter	inch	4.96	4.96	6.38	6.38
	Bearing diameter	inch	6.69	6.69	8.66	8.66
Turret	Number of tools		T10 / T12	T12	T10 / T12	T12
	Turning tool shank	inch	1.25	1.25	1.25	1.25
	Boring bar shank diameter	inch	2 (2.5)	2	2 (2.5)	2
Tailstock	Milling tool shank diameter	inch	---	1.02	---	1.02
	Tailstock travel	inch	33.46/64.96/90.16	31.89/63.39/88.58	33.46/64.96/90.16	31.89/63.39/88.58
	Tailstock spindle diameter	inch	5.91	5.91	5.91	5.91
Feedrates	Taper hole of tailstock spindle		MT.5	MT.5	MT.5	MT.5
	Tailstock spindle travel	inch	5.91	5.91	5.91	5.91
	X axis rapid traverse rate	ipm	629.92	629.92	629.92	629.92
Motor	Z axis rapid traverse rate	ipm	787.40/787.40/629.92	787.40/787.40/629.92	787.40/787.40/629.92	787.40/787.40/629.92
	Y axis rapid traverse rate	ipm	---	---	---	---
Machine size	Spindle motor	HP	29.5/24.8 (34.9/29.5)	29.5/24.8 (34.9/29.5)	34.9/29.5 (49.6/40.2)	34.9/29.5 (49.6/40.2)
	Index motor	HP	1.6	1.6	1.6	1.6
	Milling motor	HP	---	5 (10)	---	5 (10)
	X axis servo motor	HP	4 (5.4)	5.4	5.4	5.4
	Z axis servo motor	HP	5.4 (9.3)	9.3	9.3	9.3
Machine size	Y axis servo motor	HP	---	---	---	---
	Height	inch	84.84	84.84	84.84	84.84
	Width	inch	208.15/249.45/280.94	208.15/249.45/280.94	208.15/249.45/280.94	208.15/249.45/280.94
	Depth	inch	85.04/83.43/83.43	85.04/83.43/83.43	85.04/83.43/83.43	85.04/83.43/83.43
	Weight	lb	17636/19841/24691	17747/19952/24802	17857/20062/24912	17967/20172/25427

* Specifications are subject to change without notice.

Special Specification Example

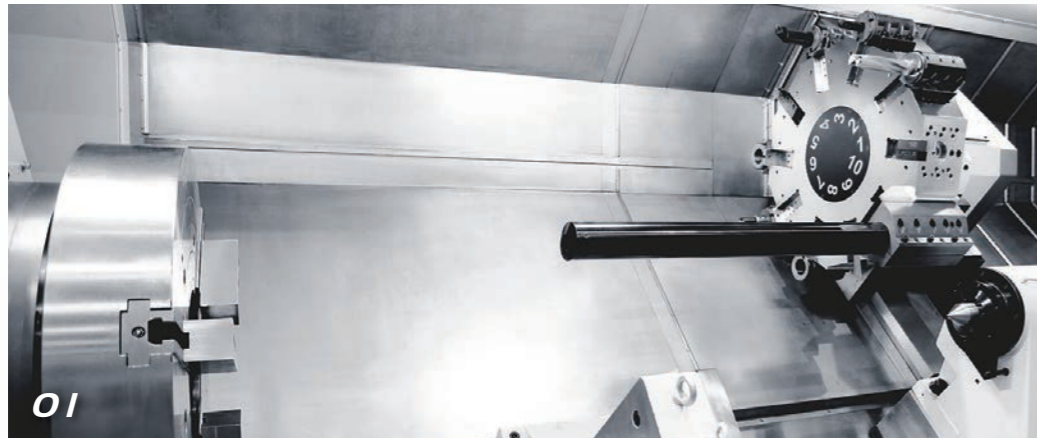

01

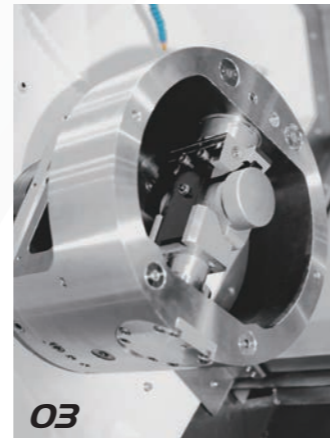

03

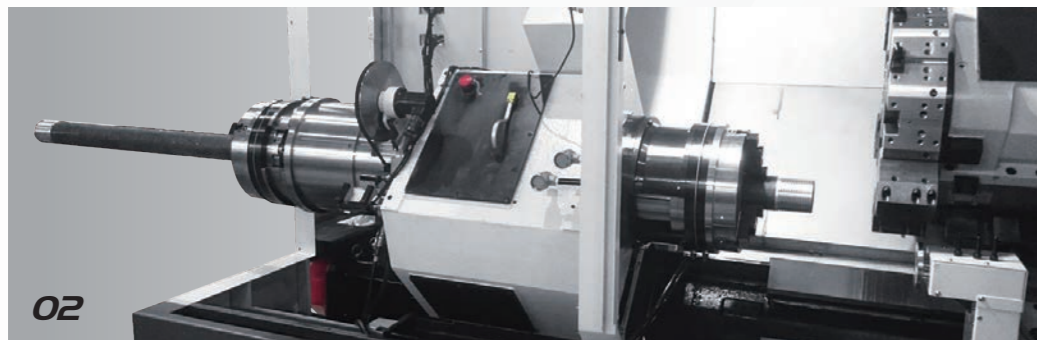

02

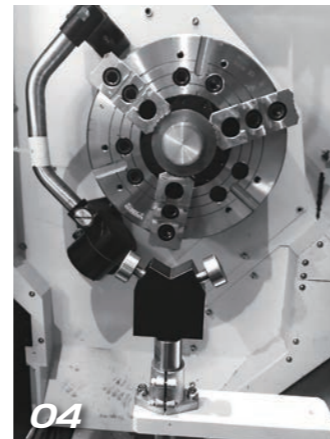

04

01
Long Boring Bar

02
Dual Chucking System

03
Indexing Chuck

04
Special Support Unit

Highly Accurate Optional Equipment

There are special requirements for precise machining accuracy and it is necessary to use approved high-precision optional equipment.

Please contact us for advice on these options.

01



02



03



04



05



06



- 01** Linear Scales
- 02** Automatic & Manual Tool Setter
- 03** Nut Cooling Ball Screw
- 04** Coolant Cooling Unit
- 05** High Pressure Coolant Unit
- 06** Hydraulic Oil Cooling Unit

Standard and Optional Accessories

● : Standard ○ : Optional --- : N/A

Item	LA-350	LA-350M	LA-450	LA-450M
Hi-low Gearbox Spindle	●	●	●	●
Hydraulic Servo Turret	●	●	●	●
Hydraulic Tailstock	●	●	●	●
Automatic Pin Actuated Tailstock	●	●	●	●
Boring Bar Tool Holder	●	●	●	●
U-drill Tool Holder	●	●	●	●
Facing Tool Holder	●	●	●	●
O.D Tool Holder	---	●	---	●
X Axis Live Tool Holder	---	●	---	●
Z Axis Live Tool Holder	---	●	---	●
Boring Bar Bush Ø1/4"	●	●	●	●
Boring Bar Bush Ø5/16"	●	●	●	●
Boring Bar Bush Ø3/8"	●	●	●	●
Boring Bar Bush Ø1/2"	●	●	●	●
Boring Bar Bush Ø5/8"	●	●	●	●
Boring Bar Bush Ø3/4"	●	●	●	●
Boring Bar Bush Ø1"	●	●	●	●
Boring Bar Bush Ø1-1/4"	●	●	●	●
Boring Bar Bush Ø1-1/2"	●	●	●	●
Boring Bar Bush Ø1-3/4"	●	●	●	●
Boring Bar Bush Ø2"	○	---	○	---
U-drill Socket Ø5/8"	●	●	●	●
U-drill Socket Ø3/4"	●	●	●	●
U-drill Socket Ø1"	●	●	●	●
U-drill Socket Ø1-1/4"	●	●	●	●
U-drill Socket Ø1-1/2"	●	●	●	●
U-drill Socket Ø2"	○	---	○	---
Drill Socket MT-1	●	●	●	●
Drill Socket MT-2	●	●	●	●
Drill Socket MT-3	●	●	●	●
Drill Socket MT-4	●	●	●	●
Drill Socket MT-5	○	---	○	---
Working Lamp	●	●	●	●
Tool Box	●	●	●	●
Operation Manual	●	●	●	●
Hydraulic Chuck	●	●	●	●
Foot Switch	●	●	●	●
Chip Conveyor	○	○	○	○
Chip Cart	○	○	○	○
Manual Steady Rest Ø1.97"-13.78"	○	○	○	○
Hydraulic Steady Rest SLU-3.2 (Ø1.97"-7.87")	○	○	○	○
Hydraulic Steady Rest SLU-4 (Ø1.18"-9.65")	○	○	○	○
Hydraulic Built-In center MT.5	○	○	○	○
Air Blow	○	○	○	○
Auto Power Off	○	○	○	○
Parts Counter	○	○	○	○
Automatic Front Door	○	○	○	○
Tool Setter	○	○	○	○
High Pressure Coolant Unit	○	○	○	○

※ Specifications are subject to change without notice.

NC Unit Specification

Controller	LA-350 LA-450	LA-350M LA-450M
0i-TF	●	●
NC Unit	LA-350 LA-450	LA-350M LA-450M
8.4" Color LCD	●	●
10.4" Color LCD	○	○
Safety Device	LA-350 LA-450	LA-350M LA-450M
Front Door Interlock	○	○
Front Door Locking Mechanism	○	○
Safety Relay	○	○
Control Panel Breaker with Tripper	○	○
Controlled Axes	LA-350 LA-450	LA-350M LA-450M
Least Input Increment	●	●
Maximum programmable Dimension(±999999.999)	●	●
Least Input Increment C	▲	▲
Inch/Metric Selection	●	●
Interlock	●	●
Machine Lock	○	○
Emergency Stop	●	●
Stored Stroke Check 1	●	●
Stored Stroke Check 2,3	●	●
Stroke Limit Check Before Movement	▲	▲
Chuck Tailstock Barrie	▲	▲
Mirror Image (Each Axis)	▲	▲
Chamfering ON/OFF	●	●
Overload Detection	▲	▲
Position Switch	●	●
Operation	LA-350 LA-450	LA-350M LA-450M
Auto Run (Memory)	●	●
MDI Run	●	●
DNC Run	●	●
DNC Run with Memory Card	●	●
Program Number Search	●	●
Sequence Number Search	●	●
Sequence Number Collation and Stop	●	●
Wrong Operation Preventive	▲	▲
Buffer Register	●	●
Dry Run	●	●
Single Block	●	●
Jog Feed	●	●
Manual Reference Point Return	●	●
Dogless Reference Point Setting	●	●
Manual Handle Feed, 1 Unit	●	●
Interpolating Functions	LA-350 LA-450	LA-350M LA-450M
Poitioning (G00)	●	●
Exact Stop Mode (G61)	●	●
Tapping Mode (G63)	●	●
Cutting Mode (G64)	●	●
Exact Stop (G09)	●	●
Linear Interpolation (G01)	●	●
Circular Interpolation (G02/03)	●	●
Dwell (G04)	●	●
Polar Coordinate Interpolation	---	●
Cylindrical Interpolation	---	●
Thread Cutting	●	●
Multiple Thread Cutting	●	●
Thread Cutting Cycle and Retraction	●	●
Continuous Thread Cutting	●	●
Variable Lead Thread Cutting	●	●
Reference Point Return (G28)	●	●

Interpolating Functions	LA-350 LA-450	LA-350M LA-450M
Reference Point Return Check (G27)	●	●
2nd Reference Point Return (G30)	●	●
3rd, 4th Reference Point Return	●	●
Feed Function	LA-350 LA-450	LA-350M LA-450M
Rapid Traverse Override (F0,25%,50%,100%)	●	●
Feed Per Minute	●	●
Feed Per Revolution	●	●
Constant Tangential Speed Control	●	●
Cutting Feedrate Clamp	●	●
Automatic Acceleration/Deceleration	●	●
Rapid Traverse Bell-Shaped Accel/Decel	●	●
Linear Accel/ Decel After Feedrate Interpolation	●	●
Feedrate Override (15 Steps)	●	●
Jog Override (15 Steps)	●	●
Override Cancel	●	●
Manual Feed Per Revolution	▲	▲
Program Input	LA-350 LA-450	LA-350M LA-450M
Tape Code (EIA/ISO Auto Recognition)	●	●
Label Skip	●	●
Parity Check	●	●
Control In/Out	●	●
Optional Block Skip, 1 Piece	●	●
Optional Block Skip (2 to 9 Pieces)	⊕	⊕
Program Number O4 Digits	●	●
Program File Name 32 Characters	●	●
Sequence Number N8 Digits	●	●
Absolute/Incremental Command	●	●
Decimal Point Input/Pocket Calculator Type Decimal Point Input	●	●
Diameter / Radius Programming (X-Axis)	●	●
Coordinate System Setting (G50)	●	●
Auto coordinate System Setting	●	●
Drawing Dimension Direct Input	●	●
G-Code System A	●	●
G-Code System B/C	▲	▲
Chamfering/Corner R Programming	●	●
Programmable Data Input	●	●
Sub Program Call (10 Levels)	●	●
Custom Macro	●	●
Additional Custom Macro	●	●
Common Variables	●	●
Single Canned Cycle	●	●
Combined Canned Cycle	●	●
Combined Canned Cycle II	●	●
Drilling Canned Cycle	●	●
Arc Radius Programming	●	●
Macro Executor	○	○
Coordinate System Shift	●	●
Coordinate System Shift Direct Input	●	●
Miscellaneous Function/ Spindle Functions	LA-350 LA-450	LA-350M LA-450M
M Function (M3 Digits)	●	●
Second Miscellaneous Function (B Function)	○	○
Spindle Functions (S4 Digits)	●	●
Constant Surface Speed Control	●	●
Spindle Orientation	●	●
Rigid Tap (Spindle Center)	●	●
Rigid Tap (Rotary Tool)	---	●

Data I/O	LA-350 LA-450	LA-350M LA-450M
RS-232C Interface for 1 ch	●	●
Fast Data Server	⊕	⊕
External Message	●	●
External Workpiece Number Search	○	○
Memory Card I/O	●	●
Tool Functions/Tool Offset Functions	LA-350 LA-450	LA-350M LA-450M
T Function (T2+2 Digits)	●	●
Tool Offsets, 99 Pieces	●	●
Tool Offsets, 200 Pieces	○	○
Tool Geometry Size Data, 100 Pieces	○	○
Tool Position Offset	●	●
Tool Diameter/ Nose R Compensation	●	●
Tool Geometry/ Wear Compensation	●	●
Tool Offset Counter Input	●	●
Tool Offset Measured Value Direct Input	●	●
Tool Offset Measured Value Direct Input B	○	○
Tool Life Management	▲	▲
Accuracy Offset Functions	LA-350 LA-450	LA-350M LA-450M
Backlash Compensation	●	●
Backlash Compensation by Rapid Traverse/ Feedrate	●	●
Editing	LA-350 LA-450	LA-350M LA-450M
Part Program Memory Capacity 512Kbyte (1280m)	●	●
Part Program Memory Capacity 2Mbyte	○	○
Registrable Programs, 400 Programs	●	●
Registrable Programs, 1000 Programs	○	○
Program Editing	●	●
Program Protection	●	●
Extended Program Editing	●	●
Background Editing	●	●

Setting/Display	LA-350 LA-450	LA-350M LA-450M
Status Display	●	●
Clock Function	●	●
Current Position Display	●	●
Program Comment Display (31 Characters)	●	●
Parameter Setting and Display	●	●
Alarm Display	●	●
Alarm Log Display	●	●
Operator Message Log Display	●	●
Operation Message Log Display	●	●
Run Hours and Parts Count Display	●	●
Actual Speed Display	●	●
Actual Spindle Speed and T Code Display	●	●
Floppy Cassette Directory Display	●	●
Grouped Directory Display and Punching	●	●
Servo Adjustment Screen	●	●
Maintenance Information Screen	●	●
Data Protection Key, 1 Kind	●	●
Help Function	●	●
Self Diagnostic Function	●	●
Scheduled Maintenance Screen	●	●
Hardware & Software System	●	●
Configuration Display	●	●
Graphic Display	●	●
Dynamic Graphic Display	○	○
Display Languages	LA-350 LA-450	LA-350M LA-450M
English	●	●
Japanese (Kanji)	▲	▲
Other Language	▲	▲
Display Language Dynamic Switching	●	●

●:Standard ○:Optional ⊕:Special
▲:Parameter setting is required ---:None

Smart Work Manager (option)

It provides simple operation and convenient function.

01

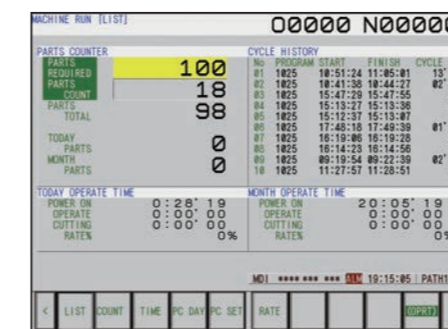

Tool Life Manager

This function can set tool life and wear limit to manage all tools.

02



Load Monitor

Detecting max load to check tool status.

03

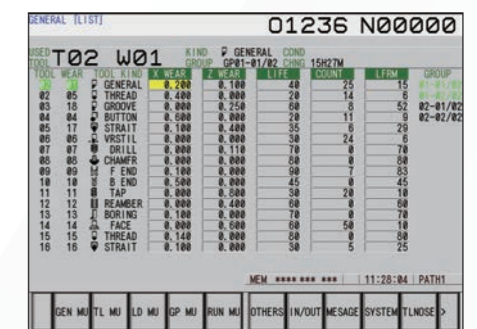

Parts and Machine Manager

It offer parts counter, program history, operate time for today or this month.